

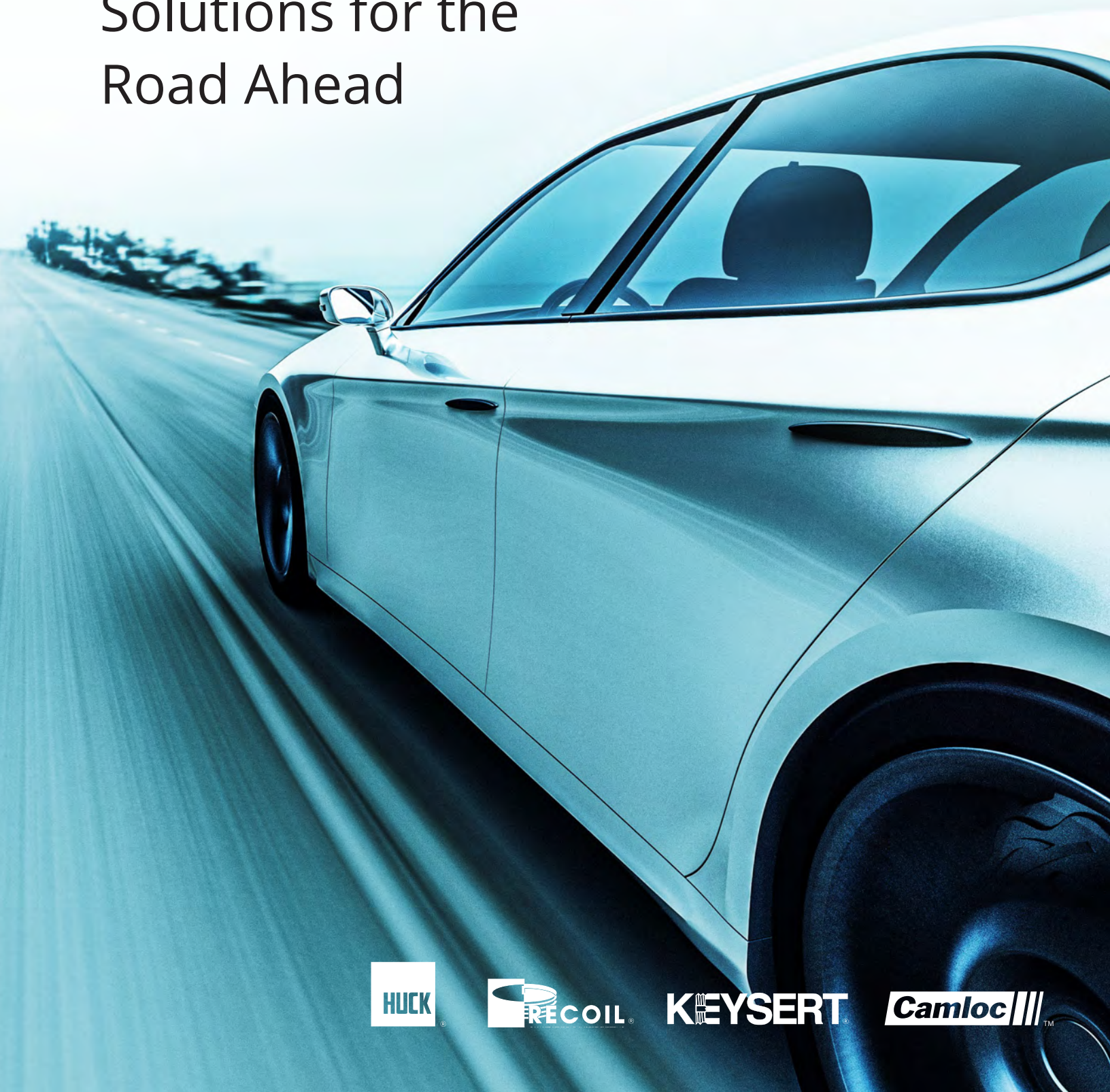

# Engineered Fastening Solutions for the Road Ahead



# Driving Automotive Assembly Technology



Howmet Fastening Systems (HFS) is a premier manufacturer of world-class fasteners for reliable, durable joining of steel, aluminum, and dissimilar materials in aircrafts, trucks, heavy equipment, specialized industries, and every type of vehicle on the road today. HFS is building on a history of excellence with engineered solutions for any fastening need in manufacturing and assembly.



Howmet's legacy brands include Huck® structural blind fasteners and 2-piece HuckBolts®, Recoil® threaded inserts, Keysert® solid inserts, Camloc® quick-release fasteners and latches, and a complete range of high-performance installation tools.

## Fully, Vertically Integrated for Single-Source Solutions

Howmet owns every step of the process from design to delivery of our finished fasteners. Our 400,000 square foot manufacturing facility in the United States features advanced cold heading, thread rolling, and machining equipment, 14 discrete heat treat furnaces finishing 170,000 pounds of fasteners per day, and

various electroplate and dip spin lines to tailor a completed fastener to your needs. By controlling every aspect of the manufacturing process, we can ensure quality workmanship and timely deliveries of the fasteners you need.

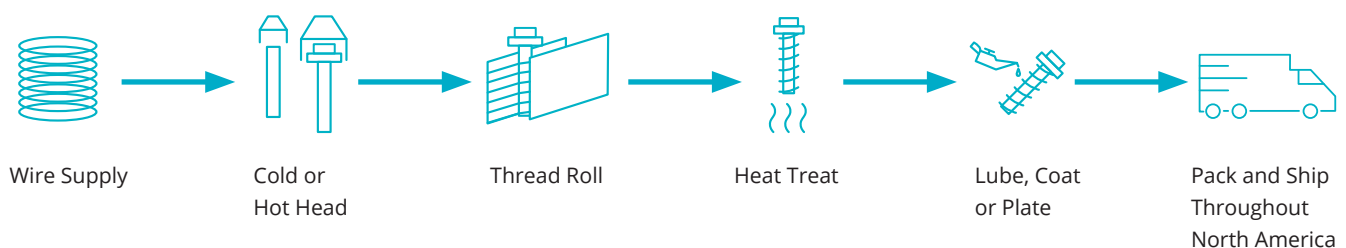



More Than a  
Source of Fasteners,  
A Source for  
Joining Solutions

# Advanced Fastening Solutions

For decades, Howmet Fastening Systems has been at the forefront of specialty fastener research and development. Our unrivaled team of top-tier engineers understands exactly how the automotive assembly floor works.

Specialized Howmet products like Enduralum®, Shoulder Bolts, Resistance Spot Rivet (RSR), and new developments in tooling and automation demonstrate Howmet's commitment to advancing fastening solutions for your most challenging automotive assembly applications.



## Lightweighting

Howmet fasteners deliver higher clamp and tensile strength than conventional fasteners, so fewer or smaller diameter fasteners can be used to reduce equipment weight without loss of durability. Advanced manufacturing processes allow for lighter weight aluminum instead of steel in many assembly joints. While welding dissimilar materials can be problematic, the strength and versatility of Howmet fasteners enable a problem-free joining solution.



## Productivity

Howmet fasteners are engineered for quick, easy installation. Unique product design and advanced tooling allows for installation of 2-piece HuckBolts in 2 seconds or less in most cases. The engineered strength of Howmet products allow for fewer fasteners to secure a joint, saving even more valuable time on the assembly line. We constantly evaluate and innovate products, tools and processes to deliver the most efficient fastening systems available.



## Vibration Resistance

The unique direct tension, swaging installation technique used for 2-piece HuckBolts results in full metal-to-metal contact between the swaged collar and the lock grooves of the bolt. This eliminates the gaps between the collar and bolt that regular nuts and bolts have, ensuring a vibration-resistant joint.



## Quality Assurance

Howmet's proprietary Huck® SureSet® Assembly Control System ensures installation integrity of each and every installed fastener. SureSet's built-in data processing unit monitors and measures hydraulic pressure to determine accuracy of installation and provides easy on-screen visual confirmation that the fastener is set correctly.

# Howmet Powers Fast, Reliable Auto Assemblies

## **Camloc** ///

### ENGINE INSERTS

Typical Application:  
- Engine Block



## **Enduralum**

### LIGHTWEIGHTING BOLTS

Typical Application:  
- Transmission and  
- Transfer Case,  
- Engine Assembly,  
- Powertrain



## **Hucklok**

### STRUCTURAL BLIND RIVETS

Typical Application:  
- Steering Column

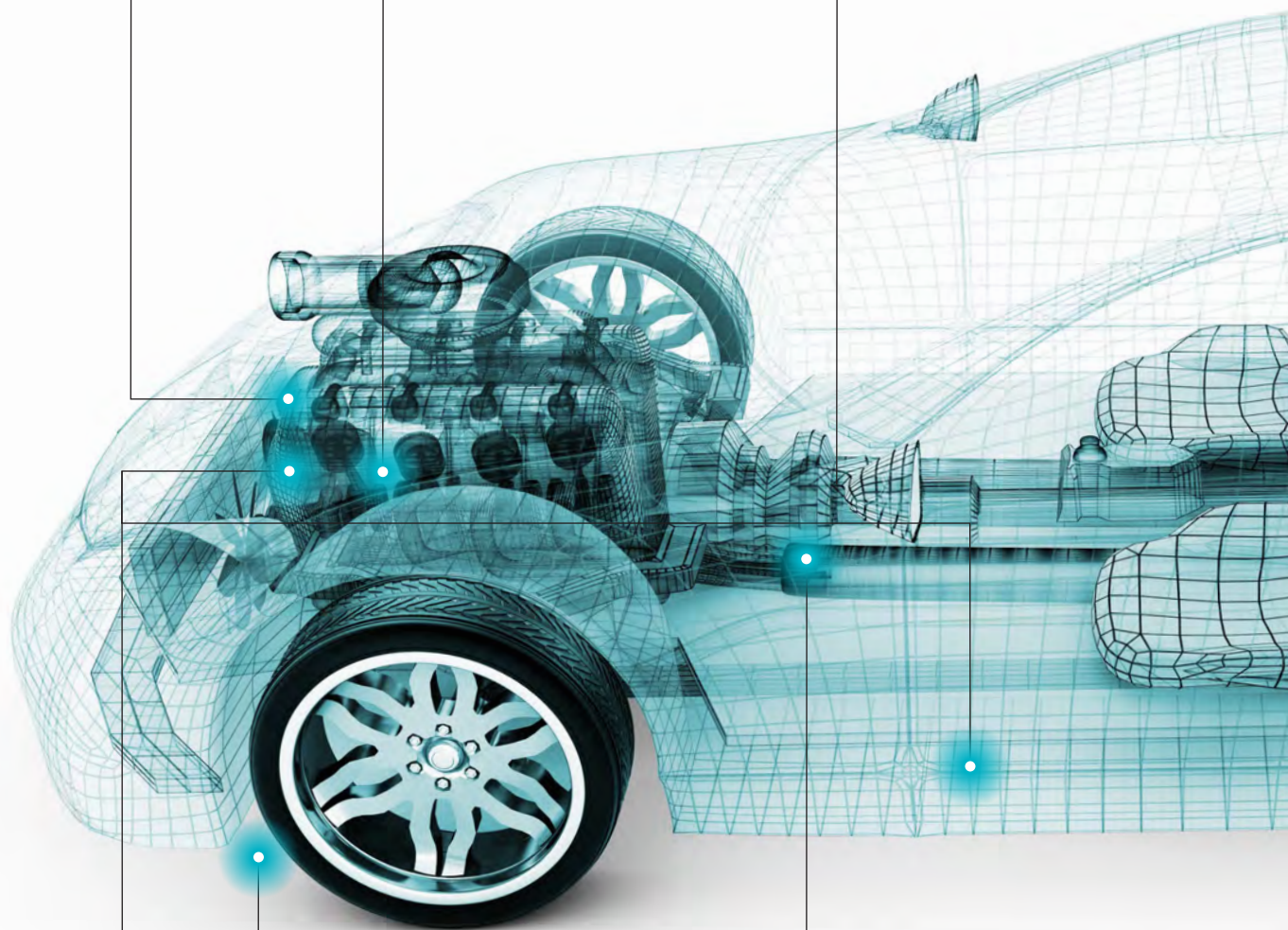

## **KEYSERT**

### SOLID INSERTS

Typical Application:  
- Engine Castings  
- Door Frames



### WIRE INSERTS

Typical Application:  
- Oil and Transmission Pans



## **Camloc** ///

### 1/4-TURN FASTENERS

Typical Application:  
- Fuse Box

# Howmet Powers Fast, Reliable Auto Assemblies



## **Shoulder Bolt** SPECIALTY FASTENERS

Typical Application:  
- Seating Structures



## LATCHES

Typical Application:  
- Trunk / Hatch

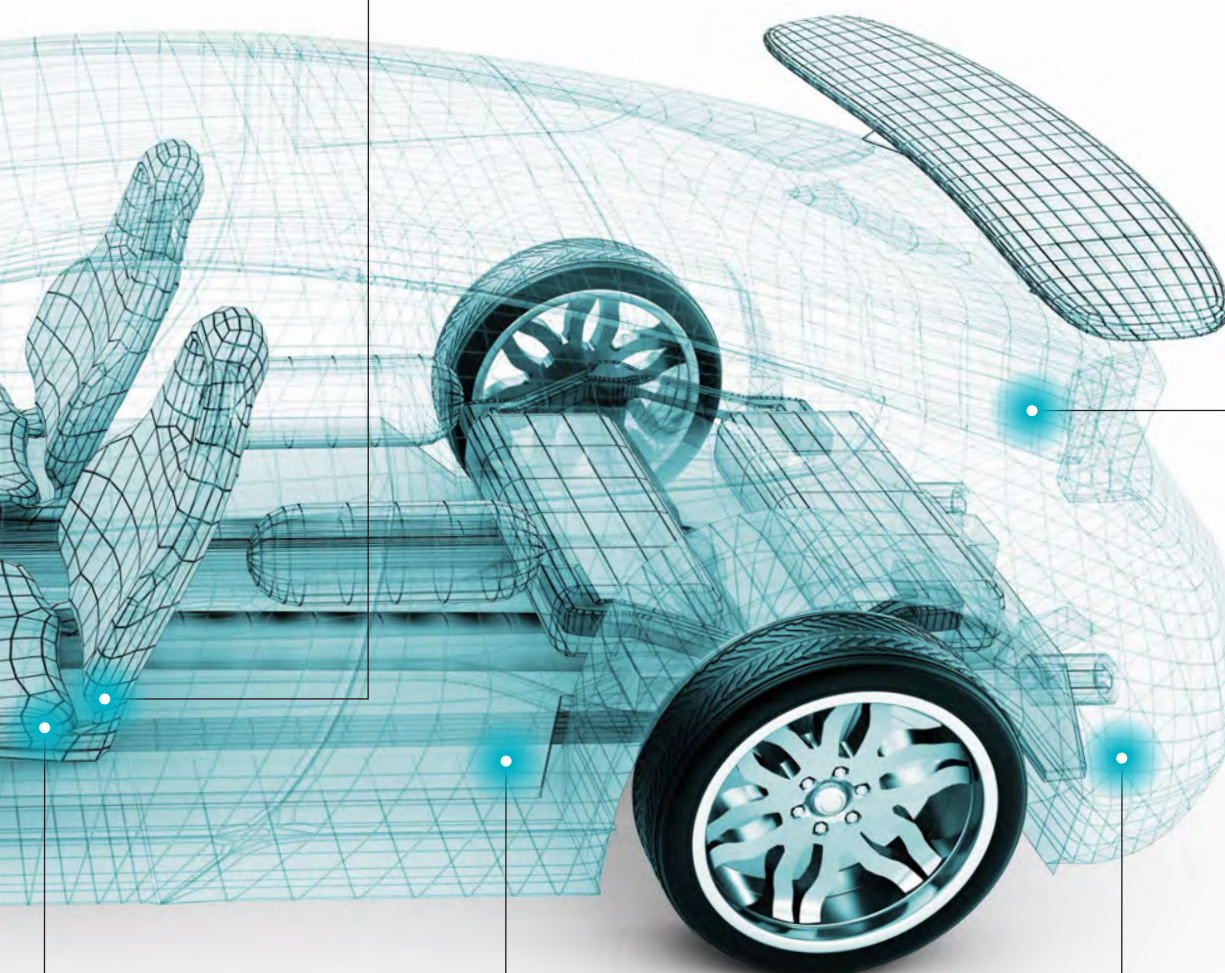

## **BobTail** HUCKBOLTS

Typical Application:  
- Seating Structures



## RSR

### MULTI-MATERIAL JOINING

Typical Application:  
- Frames,  
- Floors,  
- Closeout Panels,  
- Pillars,  
- Roofs,  
- Intrusion Beams



## **Auto-Bulb** STRUCTURAL BLIND RIVETS

Typical Application:  
- Front and Rear Bumpers

# A Strong Family of Automotive Fasteners



## Structural Blind Fasteners



### Magna-Lok®

Huck Magna-Lok is a versatile, moisture- and vibration-resistant, wide-grip range, hole-filling fastener that can be installed with conventional installation tools. It has a unique circle-lock feature, which means a simple visual inspection ensures proper installation.

Sizes: 3/16", 1/4", 3/8", 1/2"



### HuckLok®

The HuckLok structural blind rivet features a wide grip range and unique double-locking action. This action consistently secures the assembly from both sides, resulting in maximum hold and joint integrity.

Sizes: 3/16", 1/4"



### Magna-Bulb®

The Huck Magna-Bulb provides the high shear strength and high pull-out strength needed for thin materials, and oversized or misaligned holes. Its superior blind-side strength and structural integrity is provided by its unique bulbing system and positive, mechanical pin retention.

Sizes: 3/16", 1/4", 5/16"



### Auto-Bulb®

For automated, high-speed assemblies, the Huck Auto-Bulb is the ideal solution. Fast, reliable installation is provided with its easy-to-use lead-in point. It works by clamping the joint with a broad, blind-side bulb, making it ideal for use within thin materials.

Sizes: 3/16", 1/4"



### BOM®

The Huck BOM (Blind, Oversized, Mechanically locked) blind bolt is so strong, one can do the work of up to four conventional fasteners. Its unique push-and-pull installation design makes it ideal for automotive industry use.

Sizes: 3/16", 1/4", 5/16", 3/8", 1/2", 5/8", 3/4"





## Two-Piece HuckBolts®



### Huck® BobTail®

Engineered to meet the challenges of the automotive assembly application, Huck BobTail delivers high performance, vibration resistance, and ultimate reliability in a unique, pintail-less design.

Sizes: 1/4", 5/16", 3/8", 1/2", 5/8", 3/4", 7/8", 1", 12mm, 14mm, 16mm, 20mm

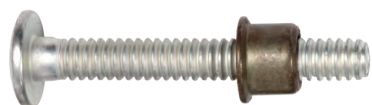

### Magna-Grip®

When a wide grip range is required and a flush bolt break to the collar is beneficial, Huck Magna-Grip is the right choice. This strong, two-piece HuckBolt offers installation reliability and provides consistently high, uniform installed values.

Sizes: 3/16", 1/4", 5/16", 3/8"



### Huck® Shoulder Bolt

These C150L, C120L and BobTail HuckBolts have a precision shoulder as pivot point and offer faster installations, a permanent and vibration-resistant joint, and easy installation integrity verification.



## Threaded Inserts



Recoil® leads the way in threaded insert systems, offering a broad selection of free-running, screw-locking, and Tangless® inserts. The Recoil system consists of precision inserts, quality high speed taps, complementary STI taps and easy-to-use installation tools for repairing damaged screw threads or creating strong new threads. Recoil helically wound screw-thread inserts are generally manufactured from Type 304 (18-8) stainless steel wire, cold rolled into a diamond shaped cross section.

Tangless is a registered trademark of Advanex Inc.



## Solid Inserts



Designed to repair damaged threads or for use in original equipment, Keysert solid inserts provide easy installation and versatility. Featuring a key-locking action that prevents rotation due to vibration or torsion. Commercial-grade Keysert inserts are available in carbon and stainless steel, both inch and metric series, and are supplied in Thinwall, Heavy Duty, Extra Heavy Duty, and Solid styles. Keysert inserts are offered individually or in kits.



## Quick-Release Fasteners and Latches

The Camloc® product line includes an extensive range of quick-release fasteners, tension latches and door locks, hinges, and handles. Typical uses for Camloc products include maintenance paneling, access hatches, external components, and a wide range of other applications where quick removal and re-attachment is required.



## Aluminum Heavyweight in Lightweighting

# Enduralum®

Enduralum® is an incredibly strong, yet remarkably lightweight, aluminum fastener designed for thermal and galvanic compatibility with next-generation aluminum and magnesium castings in automotive powertrains. The heat-treated AA 6056 Alloy of Aluminum in Enduralum helps to reduce overall weight while maximizing joint strength and ensuring industry-leading reliability.

## Howmet maintains the highest level of quality control through wire-to-box manufacturing.

- ✓ Class I continuous aluminum heat treat furnace (currently only US manufacturer)
- ✓ In-house design and prototyping capabilities
- ✓ Single-source manufacturer of custom fastener solutions

Licensed  
**MAThread**  
manufacturer

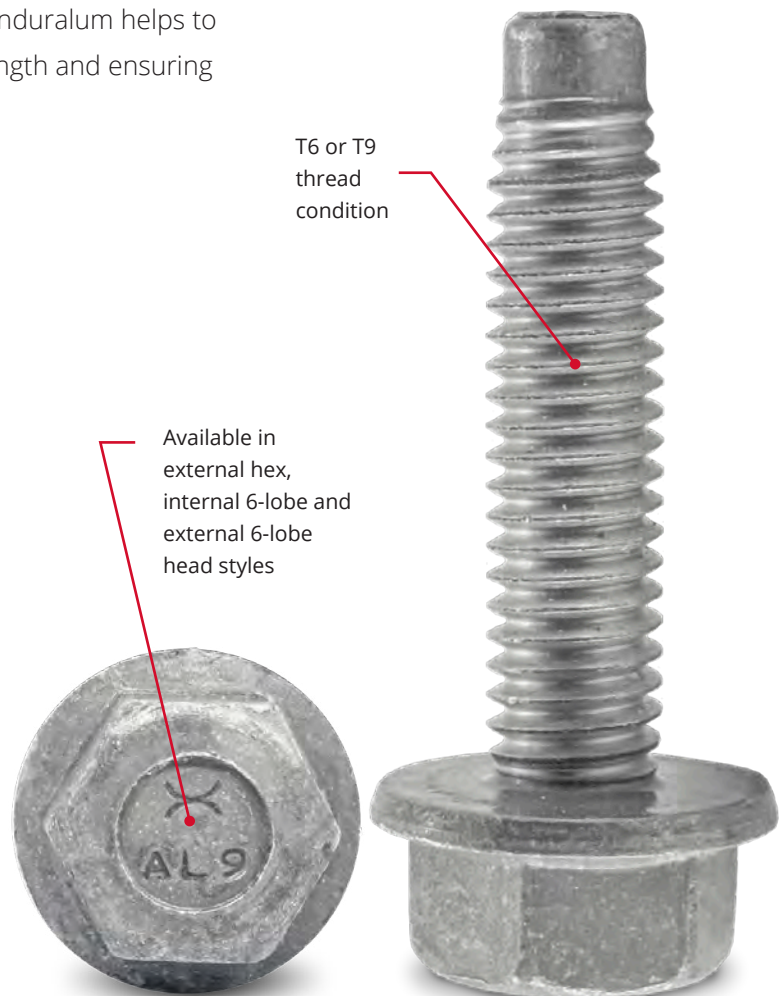

## Data and Dimensions

<b>Tensile strength (Rm):</b>	420-460 MPa
<b>Yield strength (Rp0.2):</b>	380-410 MPa
<b>Elongation (Af):</b>	>12% on fully threaded fastener
<b>Diameters:</b>	M6, M8, M10, M12
<b>Lengths:</b>	25mm-85mm

## Applications:

- ✓ Hybrid battery assemblies
- ✓ Transmission and transfer case internal and external assembly
- ✓ Engine assembly
- ✓ Powertrain cover and subcomponent attachment

# Seating Assembly and Attachment Solutions



Howmet is committed to advancing automotive manufacturing processes through engineered solutions that provide structural strength and efficient assembly and installation. This ensures fewer seating structure reworks, increased installation speed and a reduction in seating component complexity.

## Seating structure fastening options



### Huck® Shoulder Bolts

Special bolt design provides vibration resistance and high fatigue strength of HuckBolt technology, replacing threaded fasteners with permanent, consistent joints.

These specialty shoulder bolts can be custom-designed to fit any geometric or strength requirements, and inspected for integrity via either visual or automated methods.



### HuckBolts

Two-piece pin and collar design for fast swage installation of permanent and vibration resistant joints.



### Huck® Blind Fasteners

Provides structural strength and quick installation for applications with no blind-side access.



### Howmet RSR® Resistance Spot Rivet

Allows multi-material joining using traditional RSW equipment.

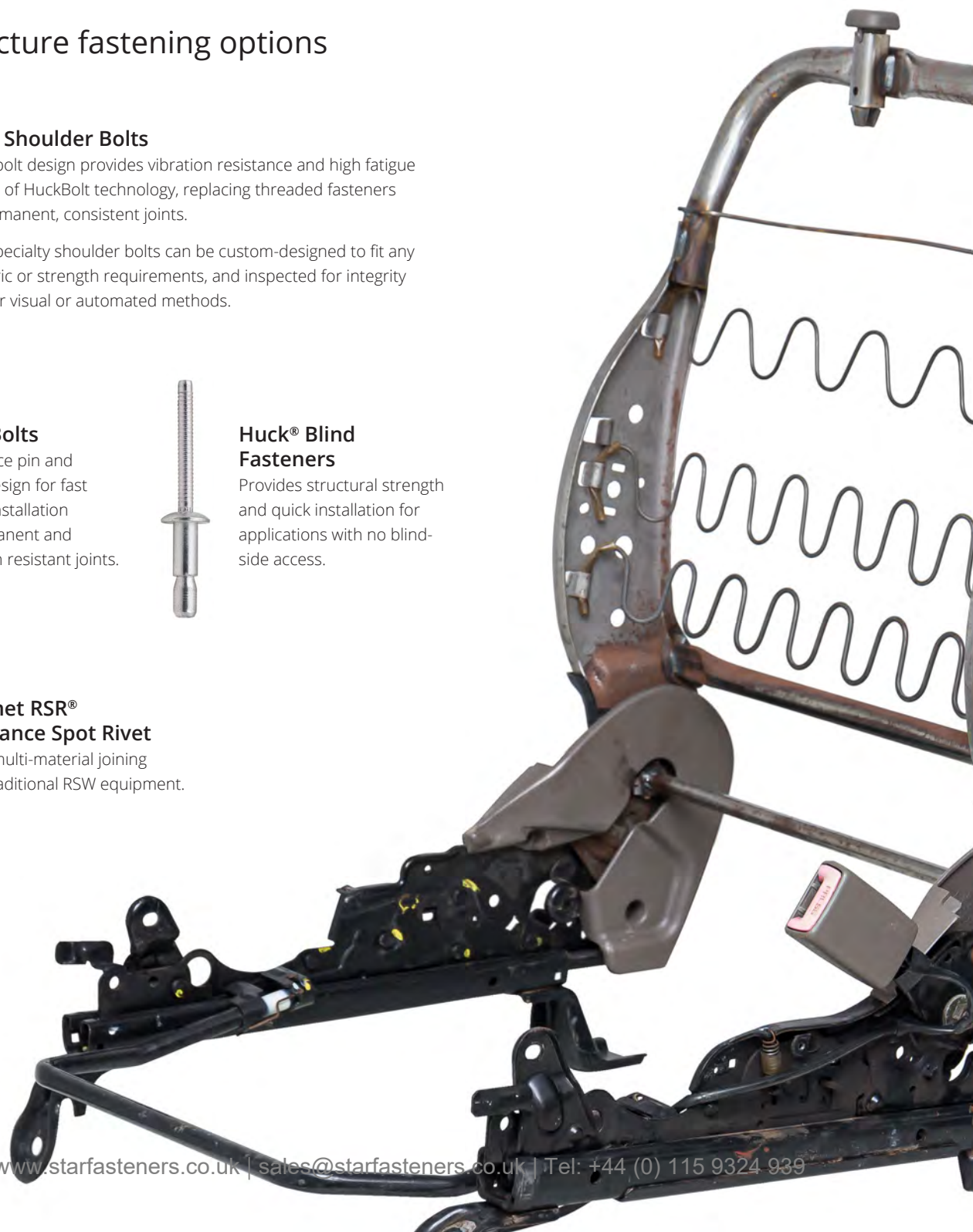



Proven  
Technology  
to Join  
Dissimilar  
Materials

# Resistance Spot Rivet (RSR®)

The growing trend towards multi-material part design inspired engineers at our Howmet Technical Center to develop a new technology called Resistance Spot Rivet (RSR®). This advancement allows a wide range of dissimilar materials to be joined quickly and reliably, including:

- ✓ High-Strength Aluminum
- ✓ Steel
- ✓ High-Strength Steel (HSS)
- ✓ Ultra-High-Strength Steel (UHSS)
- ✓ Magnesium (Mg)
- ✓ Composites



Resistance Spot Rivet technology is an effective alternative to conventional Self-Piercing Rivets (SPR) and Flow Drill Screws (FDS). It can be used in a number of automotive applications, including frames, floors, closeout panels, pillars, roofs, intrusion beams, and more.

## RSR Advantages

This breakthrough, proprietary technology offers a number of advantages to many of today's conventional joining processes:

- ✓ Reliably joins UHSS and aluminum, steel to Mg, and steel to composites
- ✓ Reliably joins 7xxx alloys to lower-strength 6xxx and 5xxx alloys
- ✓ Uses existing RSW equipment, enabling the flexibility to spot weld similar materials in sequence with dissimilar materials
- ✓ Seamlessly transitions between conventional spot welding to RSR® on the same welding equipment
- ✓ Installed rivets have no back protrusions

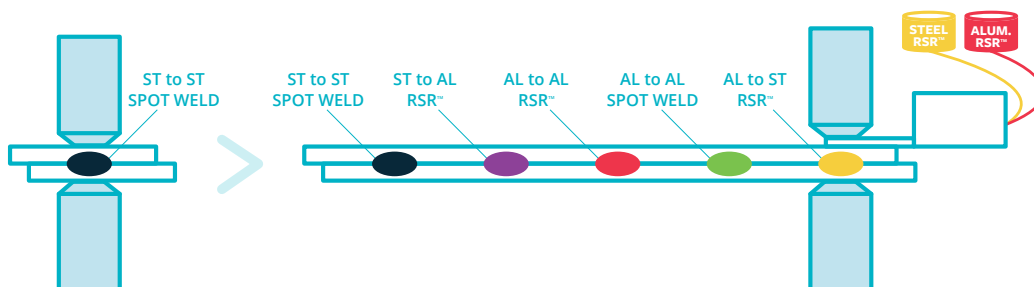

## A Wide Selection of Tooling Options

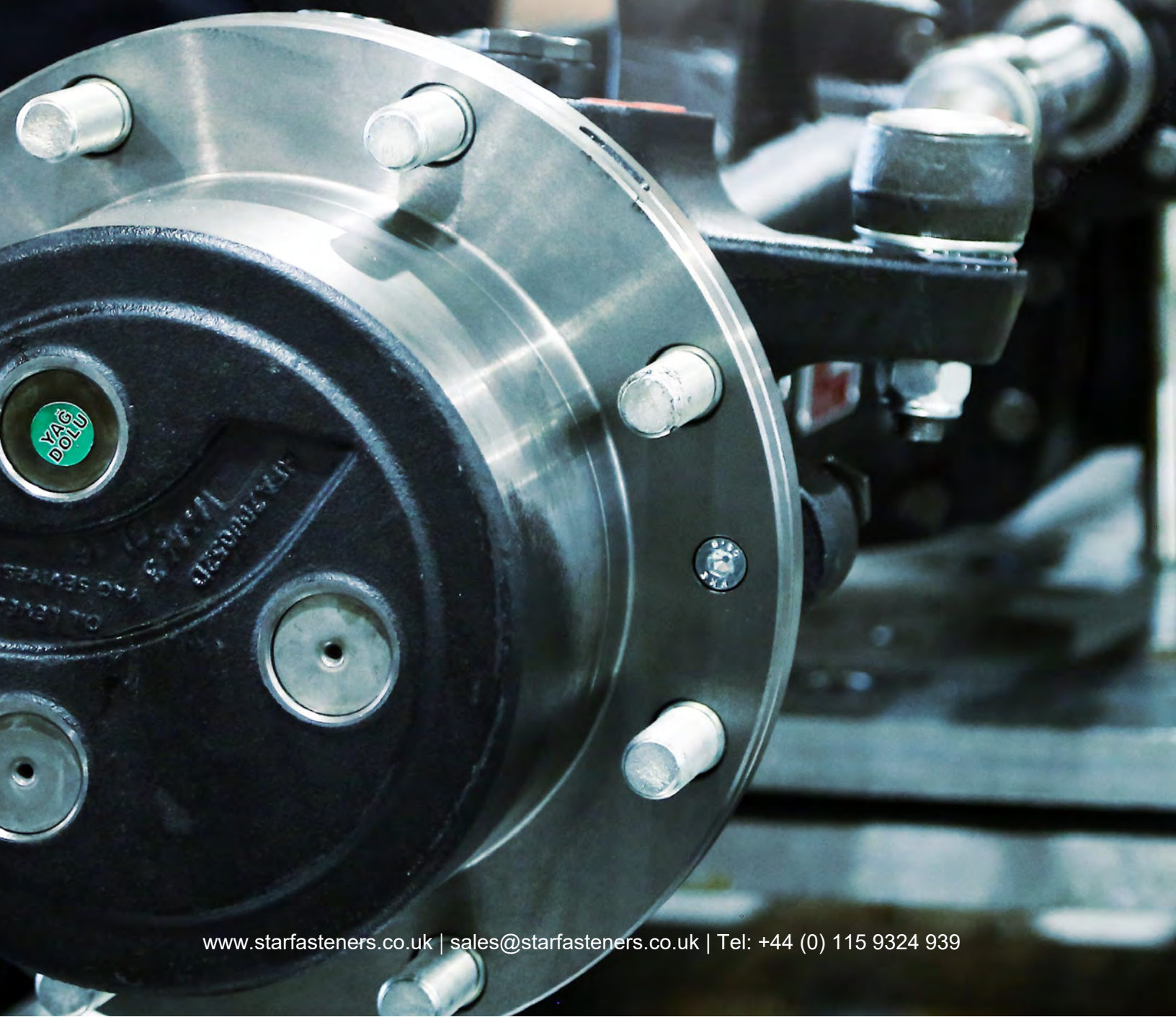



# Tooling and Power Supplies

Howmet Fastening Systems offers a broad selection of installation tools, as well as our acclaimed Powerig® hydraulic power sources. Huck hydraulic installation tools install a wide range of fasteners, from structural blind rivets to the largest HuckBolts. The Huck line of pneudraulic tools, designed for use in repair work or in lower volume production applications, can effectively pull fasteners ranging from 3/32" blind rivets to 3/8" HuckBolts. The new Makita-designed Huck Range Force battery-powered tool has an electronically adjustable pull force and long stroke to enable installation of structural and non-structural rivets and up to 1/4" two-piece HuckBolt® fasteners.\*



Huck Range Force



2480



2025

\* Excludes 1/4" BOM

# Additional Tooling Options

## Powerig® Power Supplies

Huck Powerigs offer advanced design and quality manufacturing to deliver both best-in-class performance and long product life. Whether for mobile or factory use, there is a Huck Powerig hydraulic power source for the job, from portable electric, gasoline and diesel units to larger rigs that operate up to three individual tools.



Powerig Model 940



Powerig Model 918 Series

# Huck SureSet® Assembly Control System

Howmet's Huck SureSet system checks the integrity of every installed blind or two-piece fastener. Sensors built into our high-quality Huck Powerig units measure load and piston movement (converted from hydraulic fluid pressure and flow, respectively) during the installation. The data processing unit (DPU) then uses this information to detect whether the fastener has been installed correctly.

A graphical display of every fastener installation is shown on a built-in screen which indicates any malfunctions during the installation process. This assures you that no incorrect installations leave your production line unnoticed, providing peace of mind about the quality of your product.

## Benefits

- ✓ Precise, reliable measurement and visual confirmation of every installation.
- ✓ Can be configured to enable audible alarm and system lockout features when incorrect installations are indicated.
- ✓ All measuring components are integrated into SureSet Powerig so you can use any standard Huck hydraulic tools without modifications.
- ✓ No time-consuming calibrations each time a tool is changed.
- ✓ Can be programmed with settings for up to 32 different Huck fasteners which can then be quickly and easily selected.
- ✓ Each program can be user defined to ensure maximum control over the installation process.





# Howmet Fastening Systems

## Industrial Division Brands



Huck, Marson, Recoil, Keysert, Camloc, Simmonds and Snep are trademarks of Howmet Aerospace Inc. and/or its subsidiaries.

### North America

#### Waco Operations

PO Box 8117  
8001 Imperial Drive  
Waco, TX 76714-8117  
Tel: +1 800-388-4825  
Fax: +1 800-798-4825  
[sales.waco@howmet.com](mailto:sales.waco@howmet.com)

#### Kingston Operations

1 Corporate Drive  
Kingston, NY 12401  
Tel: +1 800-278-4825  
Fax: +1 845-334-7333  
[sales.kingston@howmet.com](mailto:sales.kingston@howmet.com)

#### Tracy Operations

1925 North MacArthur Drive  
Tracy, CA 95376  
Tel: +1 800-826-2884  
Fax: +1 800-573-2645  
[sales.idg@howmet.com](mailto:sales.idg@howmet.com)

[hfsindustrial.com](http://hfsindustrial.com)

[YouTube.com/HFSIndustrial](https://www.youtube.com/HFSIndustrial)

The information contained in this publication is only for general guidance, and is not intended to create any warranty, express, implied, or statutory; all warranties are contained only in Howmet Fastening Systems' written quotations, acknowledgments, and/or purchase orders. It is recommended that the user secure specific, up-to-date data and information regarding each application and/or use of such products.

### Global

#### Telford Operations

Unit C, Stafford Park 7  
Telford, Shropshire  
England TF3 3BQ  
Tel: +44 (0) 1952-290011  
Fax: +44 (0) 1952-290459  
[sales.telford@howmet.com](mailto:sales.telford@howmet.com)

#### Melbourne Operations

1508 Centre Road  
Clayton, Victoria  
Australia 3168  
Tel: +613-8545-3333  
Fax: +613-8545-3390  
[sales.melbourne@howmet.com](mailto:sales.melbourne@howmet.com)

#### Tokyo Operations (Japan & Korea)

8F CIRCLES Nihonbashi-  
Bakurocho Bldg  
1-5-12 Nihonbashi-Bakurocho  
103-0002 Tokyo Japan  
Tel: +81-3-5642-8360  
Tel: +81-3-5642-8361 x8365  
Fax: +81-3-5644-5772

#### Suzhou Operations

58 Yinsheng Road,  
SIP Suzhou, Jiangsu  
215126 China  
Tel: +86-512-62863800-8888



The UK's largest Huck Distributor

**Star Fasteners (UK) Ltd**  
Unit 1, 44 Brookhill Road,  
Pinxton,  
Nottinghamshire  
NG16 6RY  
United Kingdom.

[sales@starfasteners.co.uk](mailto:sales@starfasteners.co.uk) | Tel: +44(0)1159324939

© 2020 Howmet Aerospace Inc. All rights reserved. HFS6075 0420  
BobTail, Magna-Grip, HuckLok, Magna-Lok, Auto-Bulb, Magna-Bulb,  
BOM, Powerig, SureSet, Enduralum, RSR, Camloc, Keysert and Recoil are  
trademarks of Howmet Aerospace Inc. and/or its subsidiaries.