

DATA SHEET

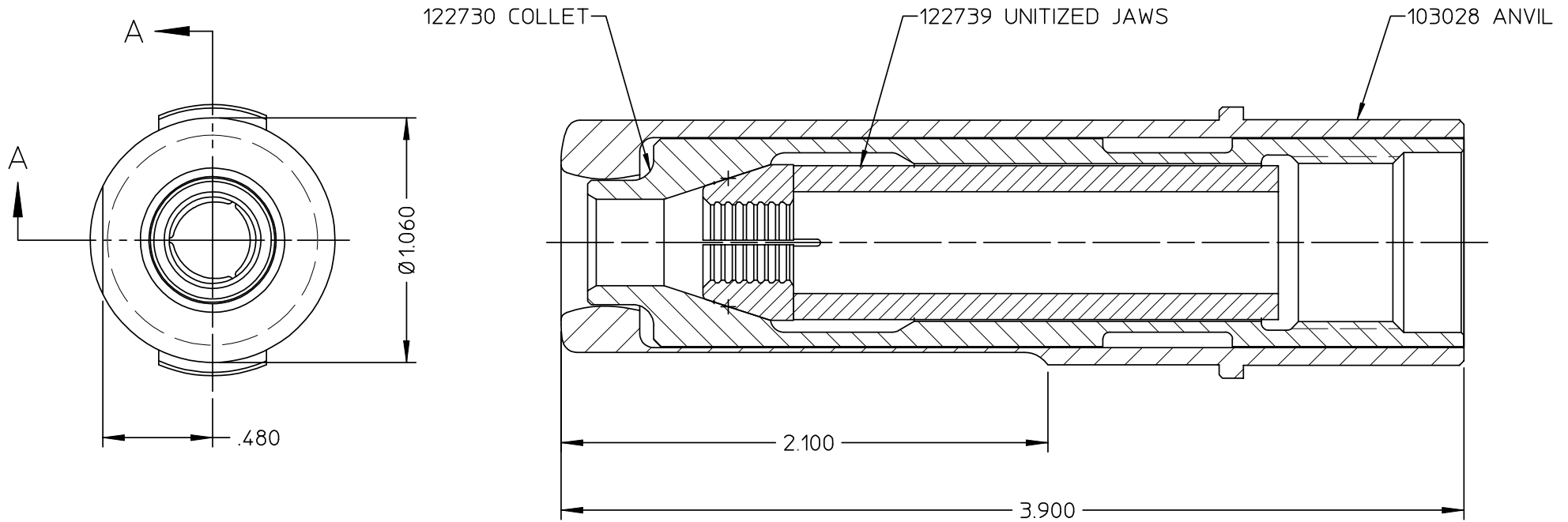

SECTION A-A

Alcoa Fastening Systems

Commercial Products
1 Corporate Drive, Kingston, NY 12401

NOSE TYPE: NON-SELF-RELEASING

FASTENER TYPE: -12 C6L

TOOL(S): 245, 246, 2502, 4801

Notes:

Product Revision: **B**

US Patent:

Date: 06/16/03

99-100-245

Part Number